



Fig. 1 Electromagnetic flow Sensor *mag-flux A*

Application

Electromagnetic flow sensors *mag-flux A* are precision measuring devices, suitable for determining the flow rate of nearly any electrically conductive fluid, but also for substances such as sludge, pulp and paste.

Due to the magnetic field, the device can be used to measure flow rates up to 10 m/s (32.8 ft/s) and a minimum conductivity of 3 $\mu\text{S}/\text{cm}$, when using a synchronized static field.

The entire measuring device comprises a flow sensor and a dedicated transmitter. Those can be delivered either separately or as a compact unit.

The electromagnetic flow sensors *mag-flux A* are applied mainly in the following industries:

- Water and sewage plants
- Chemical and pharmaceutical industry
- Food and beverage industry
- Mining, cement and mineral materials
- Pulp and paper industry
- Steel industry
- Energy industry, public utilities

Mode of operation

The units work on the principle of Faraday's law of induction, whereby, simply stated, the sensor converts the flow into voltage, proportional to the flow rate.

Special features

- solid welded steel design, therefore rugged and fail-safe
- signal amplifier inside sensor
- inside diameter of measuring tube from 15 mm (0.591")
- pressure up to 250 bar
- Liner:
 - hard rubber
 - soft rubber
 - PTFE

- special lining upon request
- various connection types and materials
- different materials and process connections
 - flange: DIN, ANSI, JIS
 - clamp
 - DIN 11851
 - and other upon request

Operating note

- The electromagnetic flow sensor is only intended for measuring the flow of electrically conductive, liquid media.
- The operator of these measuring instruments is responsible for suitability, proper use and corrosion resistance of the used materials with regard to the measuring material. It must be ensured that the materials selected for the meter parts in contact with the medium are suitable for the used process media.
- Before replacing the measuring tubes, check that the unit is free of hazardous media and is not pressurized.
- The device may only be used for the pressure and voltage limits specified on the rating plate.
- The flow meter complies with the requirements of the Pressure Equipment Directive 97/23/EC. The most hazardous permissible media are the fluids defined in group 1. See page 5
- When using flanges made from C22.8 and ST52-3, the lowest permissible temperature is -10°C (14°F).
- The sensor must not be affected by external loads.
- The units are designed for predominantly recumbent load.
- Improper installation or incorrect use of the sensors (units) may null and void any warranty.
- At the media temperatures indicated below and at $\text{DN} > 300$, the permissible max. pressure for PN10 and PN16 is reduced accordingly:

	PN 10	PN 16
< 100 °C	10,0 bar	16,0 bar
100 °C	9,3 bar	14,9 bar
130 °C	9,0 bar	14,3 bar
150 °C	8,7 bar	13,9 bar
180 °C	8,0 bar	13,0 bar

- When returning *mag-flux* sensors to Mecon, please refer to the "Product Return Form" on page 8 of this guideline. Unfortunately, we cannot repair or inspect your device without having received the completed form.
- Installation supplies (gaskets/seals, screws, etc.) are not included with the delivery.

Installation

Basically, the measuring principle does not depend on the flow profile.

Ideally, the sensor should be installed in a pipeline with a sufficient straight run, both before and after the measuring point. Experience has shown that an inflow path of $5 \times D$ and an outflow zone of at least 2 to $3 \times D$ is required.

Provided that constant turbulence does not enter the area in which the measurement takes place (e.g. after elbows, during tangential feeds or if the valve in front of the sensor is partially open). However, should this be the case, appropriate actions must be taken to normalize the flow profile. The appropriate steps are:

- increasing the inflow and outflow zones
- using flow conditioners
- reducing the inner diameter of the pipe

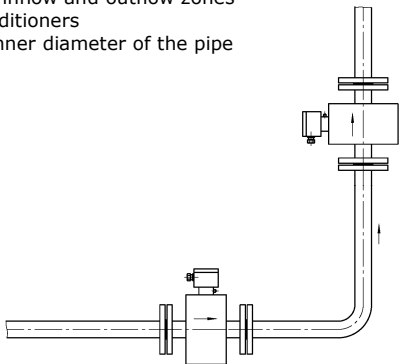

Fig. 2 Installation in horizontal and vertical pipeline

The sensors may be installed either horizontally or vertically (Fig. 2); however, it must be ensured, that the axes of the electrodes are running horizontally (see directional arrow on the electrode). This will avoid erroneous measurements due to deposits or air bubbles on the electrodes.

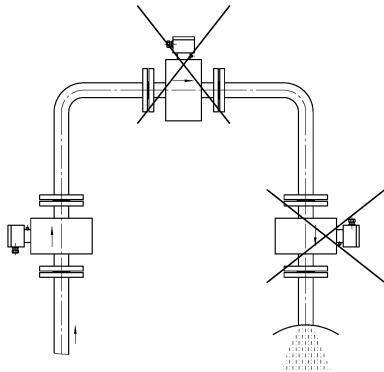

Fig. 3 Installation in risers and down pipes

Do not install the sensor in a drainage area of the pipeline (e.g. down pipe). If the sensor must be installed in a down pipe, ensure that portion of the pipeline is always filled 100% with the media.

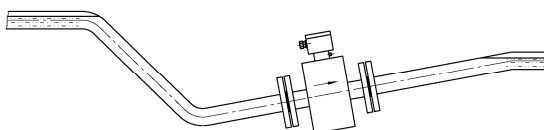

Fig. 4 Installation in a pipeline which is always filled with media

The sensor must be installed in an area of the pipe which will always be filled with media. If a pipeline is not always filled, or in case of an open channel (drainage), the sensor must be installed in a siphon (Fig. 4).

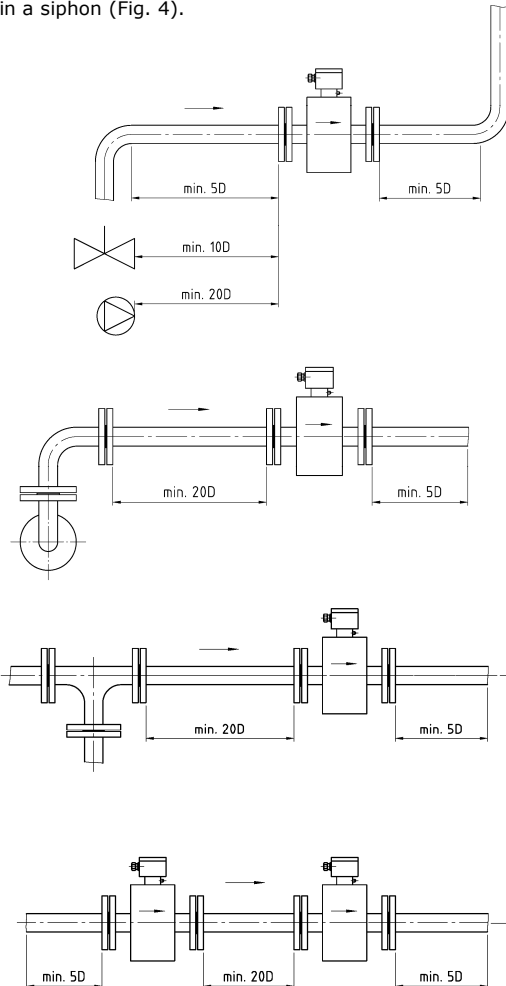

Fig. 5 Installation between tees, valves and pumps

Always maintain the distance of the pipe's straight run (Fig. 5). If these distances cannot be maintained, flow conditioners must be installed or pipes with smaller diameter must be used. If several sensors are installed in series, the distance between each sensor must be equal to the length of one sensor. If two or more sensors are to be installed in parallel, the distance between sensors must be at least 1 m.

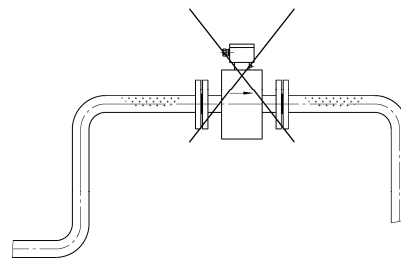

Fig. 6 Installation at highest point

Due to possible accumulation of gases, the sensor should not be installed at the highest point of a pipeline.

Technical Data

Application field	see page 1
Measuring principle	Pulsed constant field (DC)
Inlet	
Nominal diameters	DN 15 - DN 600
Process connections	<ul style="list-style-type: none"> • DIN 2501 • ANSI B 16.5 • JIS • table • special connections
Measuring accuracy	
Error of measurement	± 0,5 % of the reading from 0,25 m/s to 10 m/s
Repeat accuracy	± 0,15 % of the reading from 0,25 m/s to 10 m/s
Operational conditions	
Direction of installation	see Installation Instructions on page 2
Max. operating temperature with rubber lining	90°C/194°F; 100°C /212°F optional
with PTFE (Teflon) lining	180 °C (at 16 bar) 150 °C (at 25 bar) 100 °C (at 40 bar)
Pressure limits rubber lining	max. 250 bar
PTFE (Teflon) lining	depending on ambient temperature (see above)
Protection class	IP 67/IP 68
Requirements on the media	
Minimum conductivity	> 5 µS/cm
Max. flow rate	10 m/s
Flow rate final value	0,25 - 10 m/s
Specifications	
Design	welded steel housing
Weight	see page 5
Sensor material:	
• Measuring tube	Stainless steel mat. No. 1.4301 (or better)
• Solenoid chamber	Steel, stainless steel optional
• Flange	<ul style="list-style-type: none"> • Steel • Stainless steel • Special materials
• Lining of measuring pipe	<ul style="list-style-type: none"> • Hard rubber/soft rubber • PTFE (Teflon)
Electrodes	
• Material	<ul style="list-style-type: none"> • Mat. No. 1.4571 (Standard) • Hastelloy C4 • Titanium • Tantalum • Platinum • Monel
• Design	Mat. No. 1.4571 flat electrodes other point-plane electrodes
• Electrode sealing (rubber lining)	<ul style="list-style-type: none"> • Viton (Standard) • EPDM • Kalrez
Wiring	2 x M 16 x 1,5 / 2 x ½" NPT

Information for sensors with PTFE lining

The *mag-flux A* sensor with PTFE lining is protected using a protective disc. In order to avoid formation of a vacuum, the sensor should be installed at the lowest point of the pipeline. Do not remove or damage the bead of the lining along the flanges.

Information for sensors with soft rubber lining

Sensors with soft rubber/neoprene lining are only available from nominal diameter DN 25 mm (1").

Selection of nominal diameters

The flow depends on the flow rate and the nominal diameter DN of the flow measuring device (see system information *mag-flux* for magnetic inductive flow measurements).

Accessories

Earthing washers

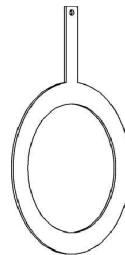

Earthing the measurement media. Necessary, if the pipes are either not electroconductive or not lined to conduct electricity (plastic pipes, concrete conduits etc.). All earthing washers must be fastened to the designated earthing screw of the sensor. See also page 4, Potential equalisation. The wall thickness of the earthing washers is 2 mm. For order code, see page 7

Protection rings for liners

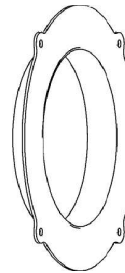

Protection rings prevent damages to the inlet and outlet edges of the sensor, in particular, if abrasive materials are being used (e.g. gravel, sand etc.); at the same time, they serve as earthing washer. They are used mainly with sensors having PTFE or soft rubber lining. The protection rings are screwed to the sensor. When used, the installation length of the NW DN 15–150 mm will be increased by 6 mm. When used with the NW 200–600 mm, the installation length increases by 10 mm. For order code, see page 7

Sensor cable

Typically, the induced signal voltage of the measuring media can be several µV or mV. The transmitter can only process these minute signals noise-free if interfering signals are avoided; these include: signals interfering with the power frequency, signals which are caused by vibrations in the pipeline or in the cable run, or signals caused by strong magnetic fields in the vicinity. In this case, sufficient shielding must be provided and, if a separate design is chosen, the signal cables must be affixed firmly. For order code, see page 7

Classification per Pressure Equipment Directive

The devices are designed, based on the directive for fluids of the hazard group Gas 1. The classification varies and depends on the design. Please see table below.
For flange material C22.8 (1.0460) and ST52-5 (1.0570) a minimum temperature of -10°C (14°F) applies. For flange material 1.4571/316Ti the lowest temperature range is -20°C (-4°F).

Nom. diameter DN (inch)	Nom. pressure PN (psi)	Permissible media	Category
15 to 25 (½ to 1)	10 to 40 (145 to 580)	Gases fluid group 1 and liquids fluid group 1	Article 3.3
32 to 100 (1¼ to 4)	10 (145)	Gases fluid group 1 and liquids fluid group 1	I
32 to 50 (1¼ to 2)	16 (232)	Gases fluid group 1 and liquids fluid group 1	I
32 to 40 (1¼ to 1½)	25 (363)	Gases fluid group 1 and liquids fluid group 1	I
100 to 350 (4 to 12)	10 (145)	Gases fluid group 1 and liquids fluid group 1	II
65 to 200 (2½ to 8)	16 (232)	Gases fluid group 1 and liquids fluid group 1	II
50 to 125 (2 to 5)	25 (363)	Gases fluid group 1 and liquids fluid group 1	II
32 to 80 (1¼ to 3)	40 (580)	Gases fluid group 1 and liquids fluid group 1	II
350 to 600 (14 to 24)	10 (145)	Gases fluid group 1 and liquids fluid group 1	III
250 to 600 (10 to 24)	16 (232)	Gases fluid group 1 and liquids fluid group 1	III
150 to 600 (6 to 24)	25 (363)	Gases fluid group 1 and liquids fluid group 1	III
100 to 600 (4 to 24)	40 (580)	Gases fluid group 1 and liquids fluid group 1	III

Tightening moments of PTFE lined components PN 25 + PN 40

DN	PN 25 (Nm)	PN 40 (Nm)
25	25	25
32	35	35
40	45	45
50	55	55
65	50	50
80	50	50
100	70	70
125	100	100
150	135	135
200	140	170
250	210	260
300	220	280
350	330	410
400	440	600
500	470	560
600	650	890
700	700	920
800	1000	1370
900	1000	1430
1000	1400	1680

Potential equalization

Typically, the induced signal voltage of the measuring media can be several μV or mV. The transmitter can only process these minute signals noise-free if the voltage applies to a solid potential (earth). A good earth connection must be provided between the sensor and the pipeline. Thus, the pipeline is earthed, and the media and therefore the signal voltage have a solid signal common.

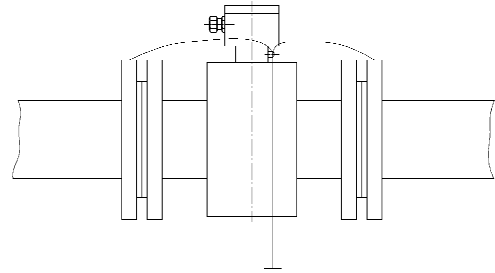

Fig. 7

When using pipes lined with electrical insulation, plastic tubing or concrete conduits, a separate earthing washer is used to earth the measuring media. The earthing washer is installed between the pipeline connection and the sensor's flange and the ring's inside contacts the media. Contrary to the diagram shown below, one earthing washer on the inflow side is sufficient. However, if bidirectional measurements are to be taken, one earthing washer must be installed on either side.

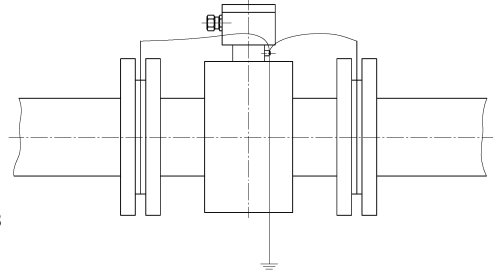

Fig. 8

Protection washers or protection rings (supplied upon request) can also be used as earthing component; or special earthing electrodes, incorporated in the sensor, may be installed. When using abrasive measuring media or pipes with large nominal diameters, earthing electrodes may prove to be more economical than earthing washers. However, it must be ensured that noticeable differences in potential within the equipment are eliminated, otherwise the earthing electrodes will electrolyze and be destroyed.

If the pipelines cannot be earthed, due to operational reasons, the sensor must be installed voltage free. To do this, a separate cable must be used to electrically connect these segments of the pipeline (min. 6mm²; not included). An electrical connection between the sensor and any material used for the installation must be avoided. Insulating segments must be installed between the sensor and the pipeline (e.g. PVC pipes or similar). Subsequently, earthing washers are used to electrically connect the media with the transmitter. The transmitter must not be connected with the protective earth conductor. This may only be done, if the auxiliary power is 24V DC.

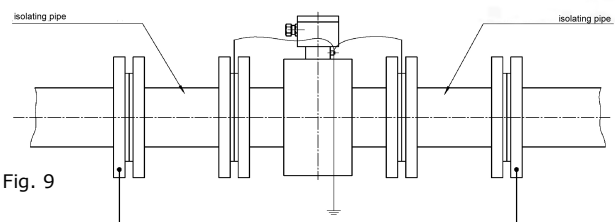

Fig. 9

Dimensions (remote version)

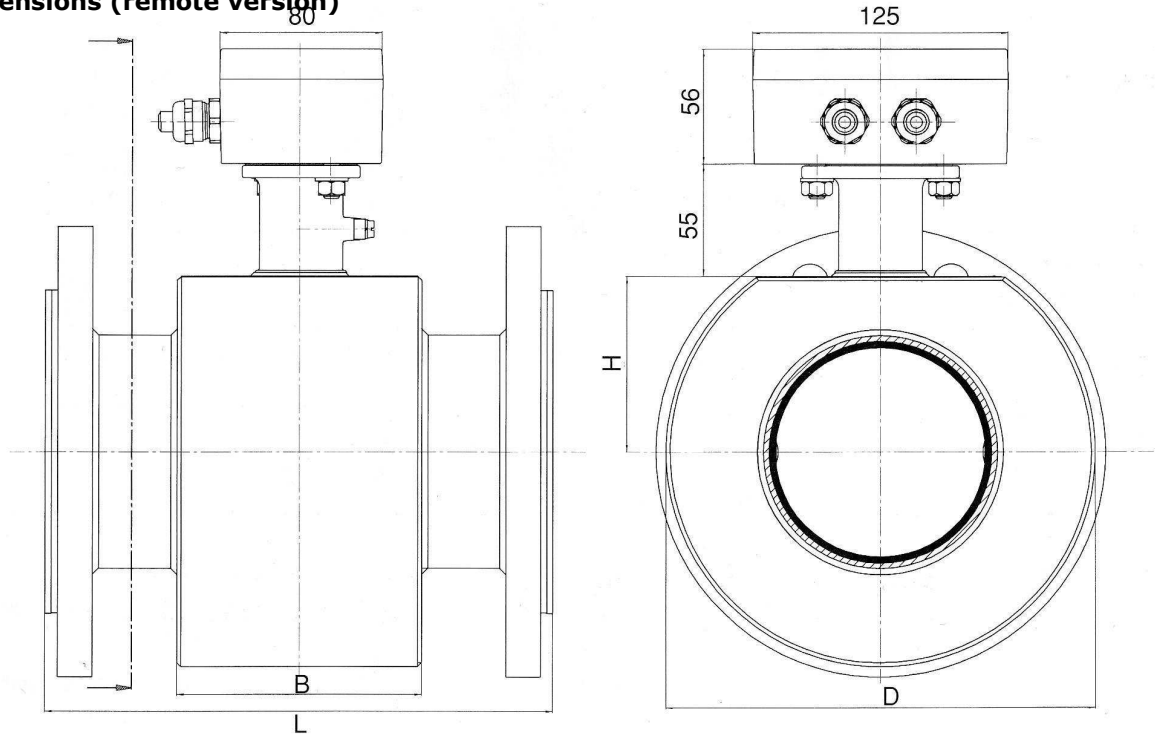

Fig. 10 Dimensions

Nominal diameter					Hard- and soft rubber	Build-in-length L PTFE			Dimension of sensor housing			Weight in kg (DIN flange)
DIN	ANSI			without protection washers		with protection washers	Tolerance	B	D	H		
DN 15	PN 40	1/2"	150 RF	200	200	206	+0 / -3	80	130	53	5	
DN 25	PN 40	1"	150 RF	200	200	206	+0 / -3	80	130	53	6	
DN 32	PN 40	1 1/4"	150 RF	200	200	206	+0 / -3	80	130	53	7	
DN 40	PN 40	1 1/2"	150 RF	200	200	206	+0 / -3	80	130	53	7,5	
DN 50	PN 40	2"	150 RF	200	200	206	+0 / -3	80	140	57	9	
DN 65	PN 16	2 1/2"	150 RF	200	200	206	+0 / -3	80	155	63	10	
DN 80	PN 16	3"	150 RF	200	200	206	+0 / -3	80	170	70	13	
DN 100	PN 16	4"	150 RF	250	250	256	+0 / -3	120	210	86	15	
DN 125	PN 16	5"	150 RF	250	250	256	+0 / -3	120	240	98	19	
DN 150	PN 16	6"	150 RF	300	300	306	+0 / -3	120	285	117	23	
DN 200	PN 10	8"	150 RF	350	350	360	+0 / -3	200	350	143	36	
DN 250	PN 10	10"	150 RF	450	450	460	+0 / -4	200	440	180	52	
DN 300	PN 10	12"	150 RF	500	500	510	+0 / -4	200	520	213	62	
DN 350	PN 10	14"	150 RF	550	550	560	+0 / -5	225	474	237	95	
DN 400	PN 10	16"	150 RF	600	600	610	+0 / -5	250	524	262	115	
DN 450	PN 10	18"	150 RF	600	600	610	+0 / -5	270	584	292	135	
DN 500	PN 10	20"	150 RF	600	600	610	+0 / -5	300	629	315	150	
DN 600	PN 10	24"	150 RF	600	600	610	+0 / -5	360	734	367	182	

Electromagnetic flow Sensor mag-flux A

Ordering data (remote version)

Electromagnetic flow sensor mag-flux A

MAG 5 7 - 2 0 - 0 0

Liner					
PTFE	0				
Hard rubber VHE / 102	1				
Hard rubber up to 100°C VHE / 109	2				
Neopren BWE/502	5				
Nominal pressure					
• PN 10 / JIS 10 K	1				
• PN 16 / 150 lbs	2				
• PN 25 / 300 lbs	3				
• PN 40	4				
• special nominal pressure	9				
Nominal diameter					
• DN 15 / 1/2"		A			
• DN 25 / 1"		C			
• DN 32 / 1 1/4"		D			
• DN 40 / 1 1/2"		E			
• DN 50 / 2"		F			
• DN 65 / 2 1/2"		G			
• DN 80 / 3"		H			
• DN 100 / 4"		J			
• DN 125 / 5"		K			
• DN 150 / 6"		L			
• DN 200 / 8"		M			
• DN 250 / 10"		N			
• DN 300 / 12"		P			
• DN 350 / 14"		Q			
• DN 400 / 16"		R			
• DN 450 / 18"		Y			
• DN 500 / 20"		S			
• DN 600 / 24"		T			
• other nominal diameters		Z			
Connection and connection material					
• DIN 2501, mat.No. 1.0460/ 1.0570		A			
• DIN 2501, mat.No. 1.4571		B			
• ANSI B16.5 150 RF, mat.No. 1.0432/ 1.0570		C			
• ANSI B16.5 300 RF, mat.No. 1.0432/ 1.0570		D			
• other connections / other materials		Z			
Electrode material					
• Stainless steel (mat.No. 1.4571)			1		
• Hastelloy C4 (mat.No. 2.4610)			2		
• Titanium			3		
• Tantalum			4		
• Monel			5		
• Platinum			6		
Cable gland entires					
• M 16 x 1,5				C	
• NPT 1/2"				B	
Degree of protection					
• IP 67 / NEMA 5				B	
• IP 68 / NEMA 6 with 5m firmly connected cable				C	
• IP 68 / NEMA 6 with 10m firmly connected cable				D	

Further designs / Options

• one grounding electrode made of mat.No. 1.4571	A 0 1
• two grounding electrodes made of mat.No. 1.4571	A 0 2
• one grounding electrode made of mat.No. 2.4610	A 0 3
• two grounding electrodes made of mat.No. 2.4610	A 0 4
• one grounding electrode made of Titanium	A 0 5
• two grounding electrodes made of Titanium	A 0 6
• one grounding electrode made of Tantalum	A 0 7
• two grounding electrodes made of Tantalum	A 0 8
• one grounding electrode made of Monel	A 0 9
• two grounding electrodes made of Monel	A 1 0
• one grounding electrode made of Platinum	A 1 1
• two grounding electrodes made of Platinum	A 1 2
• with 3-point calibration certificate	B 0 6
• with 6-point calibration certificate	B 0 7
• TAG plate inscription in english	B 1 1
• acceptance test EN 10204:2004 3.1	C 1 2
• Silicone-free materials	Y 0 4
• TAG plate stainless steel	Y 1 7

Dimensions (compact version)

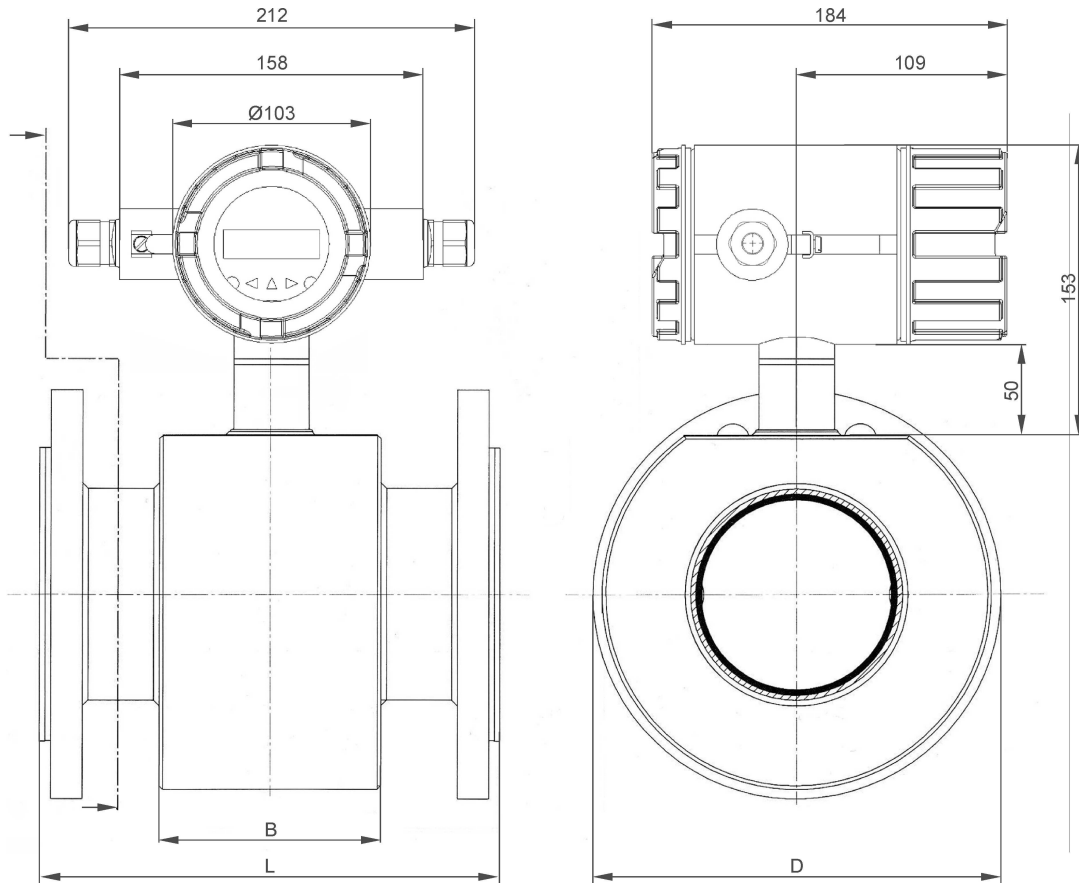

Nominal diameter	Build-in-length L		Hard- and soft rubber	PTFE		Tolerance	Dimension of sensor housing			Weight in kg (DIN flange)	
	DIN	ANSI		without protection washers	with protection washers		B	D	H		
DN 15	PN 40	1/2"	150 RF	200	200	206	+0 / -3	80	130	53	5
DN 20	PN 40	3/4"	150 Rf	200	200	206	+0 / -3	80	130	53	5,5
DN 25	PN 40	1"	150 RF	200	200	206	+0 / -3	80	130	53	6
DN 32	PN 40	1 1/4"	150 RF	200	200	206	+0 / -3	80	130	53	7
DN 40	PN 40	1 1/2"	150 RF	200	200	206	+0 / -3	80	130	53	7,5
DN 50	PN 40	2"	150 RF	200	200	206	+0 / -3	80	140	57	9
DN 65	PN 16	2 1/2"	150 RF	200	200	206	+0 / -3	80	155	63	10
DN 80	PN 16	3"	150 RF	200	200	206	+0 / -3	80	170	70	13
DN 100	PN 16	4"	150 RF	250	250	256	+0 / -3	120	210	86	15
DN 125	PN 16	5"	150 RF	250	250	256	+0 / -3	120	240	98	19
DN 150	PN 16	6"	150 RF	300	300	306	+0 / -3	120	285	117	23
DN 200	PN 10	8"	150 RF	350	350	360	+0 / -3	200	350	143	36
DN 250	PN 10	10"	150 RF	450	450	460	+0 / -4	200	440	180	52
DN 300	PN 10	12"	150 RF	500	500	510	+0 / -4	200	520	213	62
DN 350	PN 10	14"	150 RF	550	550	560	+0 / -5	225	474	237	95
DN 400	PN 10	16"	150 RF	600	600	610	+0 / -5	250	524	262	115
DN 450	PN 10	18"	150 RF	600	600	610	+0 / -5	270	584	292	135
DN 500	PN 10	20"	150 RF	600	600	610	+0 / -5	300	629	315	150
DN 600	PN 10	24"	150 RF	600	600	610	+0 / -5	360	734	367	182

Electromagnetic flow Sensor *mag-flux A*

Ordering data (compact version)

Electromagnetic flow sensor *mag-flux A*

	MAG 5 7	- 1	0 -	
Liner				
PTFE	0			
Hard rubber VHE / 102	1			
Hard rubber up to 100°C VHE / 109	2			
Neopren BWE/502	5			
Nominal pressure				
• PN 10 / JIS 10 K	1			
• PN 16 / 150 lbs	2			
• PN 25 / 300 lbs	3			
• PN 40	4			
• special nominal pressure	9			
Nominal diameter				
• DN 15 / 1/2"		A		
• DN 25 / 1"		C		
• DN 32 / 1 1/4"		D		
• DN 40 / 1 1/2"		E		
• DN 50 / 2"		F		
• DN 65 / 2 1/2"		G		
• DN 80 / 3"		H		
• DN 100 / 4"		J		
• DN 125 / 5"		K		
• DN 150 / 6"		L		
• DN 200 / 8"		M		
• DN 250 / 10"		N		
• DN 300 / 12"		P		
• DN 350 / 14"		Q		
• DN 400 / 16"		R		
• DN 450 / 18"		Y		
• DN 500 / 20"		S		
• DN 600 / 24"		T		
• other nominal diameters		Z		
Connection and connection material				
• DIN 2501, mat.No. 1.0460/ 1.0570		A		
• DIN 2501, mat.No. 1.4571		B		
• ANSI B16.5 150 RF, mat.No. 1.0432/ 1.0570		C		
• ANSI B16.5 300 RF, mat.No. 1.0432/ 1.0570		D		
• other connections / other materials		Z		
Electrode material				
• Stainless steel (mat.No. 1.4571)			1	
• Hastelloy C4 (mat.No. 2.4610)			2	
• Titanium			3	
• Tantalum			4	
• Monel			5	
• Platinum			6	
Power Supply				
• AC 230 V, 50/60 Hz				1
• AC 115 V, 50/60 Hz				2
• DC 18-36 V				3
Analogue output				
• 4 - 20 mA				B
• 4 - 20 mA with HART-protocol				C
Operating and display panel				
• without				A
• with				B
Cable glands				
• M20/M16 x 1,5				1
• 1/2" - 14 NPT				2

Further designs / Options

- one grounding electrode made of mat.No. 1.4571 **A 01**
- two grounding electrodes made of mat.No. 1.4571 **A 02**
- one grounding electrode made of mat.No. 2.4610 **A 03**
- two grounding electrodes made of mat.No. 2.4610 **A 04**
- one grounding electrode made of Titanium **A 05**
- two grounding electrodes made of Titanium **A 06**
- one grounding electrode made of Tantalum **A 07**
- two grounding electrodes made of Tantalum **A 08**
- one grounding electrode made of Monel **A 09**
- two grounding electrodes made of Monel **A 10**
- one grounding electrode made of Platinum **A 11**
- two grounding electrodes made of Platinum **A 12**
- with 3-point calibration certificate **B 06**
- with 6-point calibration certificate **B 07**
- with 5-point calibration certificate **B 08**
- TAG plate inscription in english **B 11**
- acceptance test EN 10204:2004 3.1 **C 12**
- measuring range: 0 to ... m³/h add in clear text **Y 01**
- Silicone-free materials **Y 04**
- measuring-point number (max. 16 char.) specify in plain text **Y 15**
- measuring-point description (max. 27 char.) specify in plain text **Y 16**
- TAG plate stainless steel **Y 17**

Ordering data (earthing washer)

MAG5901 - 0 - 0 AAA0

Liner

- Hard rubber / Soft rubber
- PTFE

1 A
0 B

Nominal diameter

- DN 15 / 1/2"
- DN 25 / 1"
- DN 32 / 1 1/4"
- DN 40 / 1 1/2"
- DN 50 / 2"
- DN 65 / 2 1/2"
- DN 80 / 3"
- DN 100 / 4"
- DN 125 / 5"
- DN 150 / 6"
- DN 200 / 8"
- DN 250 / 10"
- DN 300 / 12"
- DN 350 / 14"
- DN 400 / 16"
- DN 450 / 18"
- DN 500 / 20"
- DN 600 / 24"
- other nominal diameters

A
C
D
E
F
G
H
J
K
L
M
N
P
Q
R
Y
S
T
Z

Connection

- DIN 2501
- ANSI B16.5 RF
- other connections

1
2
9

Ordering data (protection ring)

MAG5911 - 0 - 0 AAA0

Liner

- Hard rubber / Soft rubber
- PTFE

1 A
0 B

Nominal diameter

- DN 15 / 1/2"
- DN 25 / 1"
- DN 32 / 1 1/4"
- DN 40 / 1 1/2"
- DN 50 / 2"
- DN 65 / 2 1/2"
- DN 80 / 3"
- DN 100 / 4"
- DN 125 / 5"
- DN 150 / 6"
- DN 200 / 8"
- DN 250 / 10"
- DN 300 / 12"
- DN 350 / 14"
- DN 400 / 16"
- DN 450 / 18"
- DN 500 / 20"
- DN 600 / 24"
- other nominal diameters

A
C
D
E
F
G
H
J
K
L
M
N
P
Q
R
Y
S
T
Z

Connection

- DIN 2501
- ANSI B16.5 RF
- other connections

1
2
9

Ordering data (sensor cable)

MAG5930 - 0 - A00 - 0 AAA0

Sensor cable consisting of:

- Magnet current cable (3 x 1,0 mm²)
- Electrode cable (3 x 1,0 mm²)

- Length: 5 m
- Length: 15 m
- Length: specify other length in plain text

B
C
Z

Product Return Form

Due to legal rules and regulations, as well as for the protection of our employees and our own facilities, we require this CONTAMINATION DECLARATION to be filled out and signed, before we can process your order.

Prior to shipping the device, any media residue must be removed. This is particularly important, if the media is potentially hazardous to health or the environment.

It is imperative that this completed and signed declaration is part of the shipping documentation. This also applies to additional safety data sheets and/or special requirements for handling the measuring media.

Company details:

Company:
.....
.....

Address:
.....
.....

Name:

Phone no.:

Sensor information:

Type:

Kom.Nr.:

Media warning signs:



poisonous



harmful to-
health



corrosive



radioactive



safe



explosive



in-
flammable



environmental
hazard

(Cross out if not applicable)

We hereby declare, that all devices returned have been cleaned, compliant with the safety regulations pertaining to hazardous materials, and that all media has been removed accordingly. No hazardous or poisonous substances remain in the device and no harm will come to either people or the environment that could be caused by residue of the measuring media.

Date:

Signature: